

Intensified Thermal Conductivity and Convective Heat Transfer of Ultrasonically Prepared CuO–Polyaniline Nanocomposite Based Nanofluids in Helical Coil Heat Exchanger

Abhishek Lanjewar¹, Bharat Bhanvase^{1*}, Divya Barai¹, Shivani Chawhan¹, Shirish Sonawane²

¹ Department of Chemical Engineering, Laxminarayan Institute of Technology, Rashtrasant Tukadoji Maharaj Nagpur University, Nagpur 440033, MS, India

² Department of Chemical Engineering, National Institute of Technology, Warangal-506004, Telangana, India

* Corresponding author, e-mail: bharatbhanvase@gmail.com

Received: 12 October 2018, Accepted: 08 January 2019, Published online: 03 June 2019

Abstract

In this study, investigation of convective heat transfer enhancement with the use of CuO–Polyaniline (CuO–PANI) nanocomposite based nanofluid inside vertical helically coiled tube heat exchanger was carried out experimentally. In these experiments, the effects of different parameters such as Reynolds number and volume % of CuO–PANI nanocomposite in nanofluid on the heat transfer coefficient of base fluid have been studied. In order to study the effect of CuO–PANI nanocomposite based nanofluid on heat transfer, CuO nanoparticles loaded in PANI were synthesized in the presence of ultrasound assisted environment at different loading concentration of CuO nanoparticles (1, 3 and 5 wt.%). Then the nanofluids were prepared at different concentrations of CuO–PANI nanocomposite using water as a base fluid. The 1 wt.% CuO–PANI nanocomposite was selected for the heat transfer study for nanofluid concentration in the range of 0.05 to 0.3 volume % and Reynolds number range of was 1080 to 2160 (± 5). Around 37 % enhancement in the heat transfer coefficient was observed for 0.2 volume % of 1 wt.% CuO–PANI nanocomposite in the base fluid. In addition, significant enhancement in the heat transfer coefficient was observed with an increase in the Reynolds number and percentage loading of CuO nanoparticle in Polyaniline (PANI).

Keywords

CuO–PANI nanocomposite based nanofluid, helical coil tube heat exchanger, CuO loading, ultrasound, heat transfer coefficient

1 Introduction

The need of efficient heat transfer has always been a serious matter as far as process cost is concerned. There are many fields where heat transfer is essential right from a car radiator to spacecraft thermal applications, from air-conditioning systems to nuclear reactors and from small electronic devices to large industrial process equipments. These applications utilize different kind of heat transfer devices that provide varying degrees of heat transfer. Simple modifications like vibration of heating surface, injection and suction of fluids, application of electrical and magnetic fields in these devices to increase the heat transfer have been studied by several researchers [1]. Also, the use of conventional heat transfer fluids like water, ethylene glycol etc. does not seem to be offering high heat transfer. Thus, there arose a need of using solid particles dispersed in base fluids to increase the thermal conductivity of the base fluids due to the fact that solids have higher

thermal conductivity than liquids. Many research groups made use of solid particles dispersed in liquids but were discontent with the results. This was reported to be happening due to various disadvantages like settling, erosion, clogging, increased pressure drop etc. exhibited by the micrometer-sized particles due to their large size [2]. This was again overcome by introducing nanometer-sized particles into base fluids as invented by Choi [3] and named as ‘Nanofluids’. Nanofluids are uniform suspensions of nanoparticles in various kinds of base fluids. They have been used to enhance the thermal conductivity and in convective heat transfer studies by many researchers [4–8]. There are many fields where nanofluids find applications which include automobile radiator [9, 10], solar applications [11–13], electronic applications [14, 15], biomedical applications [16, 17], industrial cooling applications [18, 19], anti-bacterial applications [20–22], targeted drug

delivery [23]. Application of nanofluids can be coupled with usage of modified heat transfer devices. A helical coil heat exchanger can be used instead of straight tube heat exchanger as a way of augmenting heat transfer [24]. There are many advantages that helical coil provides like high heat transfer coefficient, compact size, high heat transfer area, reduced fouling etc.

Kumar et al. [25] investigated heat transfer provided by Al_2O_3 /water nanofluid in a shell and helical coiled tube heat exchanger. It was reported that the presence of nanoparticles in the fluid flowing through the helical coil intensifies the formation of secondary flow and promotes mixing of the fluid. Kahani et al. [26] have reported that the secondary flow taking place in helical coil improves heat transfer significantly more than that in straight tube. Kumar et al. [27] also reported very little pressure drop provided by the nanofluid in the helical coiled tube with enhanced heat transfer. A numerical study of fully developed flow in helical coil has been studied by Liu and Masliyah [28]. They reported that the Dean number [$\text{De} = \text{Re} (d/D)^{1/2}$] is a controlling parameter in helical coil. It plays the same role as Reynolds number in a straight tube.

Polyaniline (PANI) based nanofluids have been studied earlier and it has been reported that it gives higher thermal conductivity [29] and a higher heat transfer coefficient [30]. Bhanvase et al. [31] studied heat transfer enhancement in vertical helically coiled tube heat exchanger using PANI/water nanofluids. Further, the thermal conductivity of the base fluid can be enhanced by using CuO nanoparticles is already known [32, 33], there have also been studies of application of CuO based nanofluids in helical coil heat exchangers. Hashemi and Akhavan-Behabadi [34] studied the characteristics of heat transfer and pressure drop for CuO/base oil nanofluid flowing inside horizontal helical tube. Fule et al. [35] also studied heat transfer enhancement in helical coil heat exchanger using CuO nanofluids and reported enhancement in the heat transfer.

The idea that may come into one's mind is to combine PANI and CuO and prepare a nanofluid that may give better performance than that given by nanofluids prepared using both components individually. CuO–PANI nanocomposites have already been found to exhibit synergistic hybrid properties which are derived from both its components [36]. Bhanvase et al. [37] have studied convective heat transfer by using PANI and PANI–CuO nanofluids. The higher enhancement offered by PANI–CuO nanofluid is attributed to the PANI encapsulated CuO nanocomposite. The detailed literature review is depicted in the

Table 1, which provides the insight of the enhancement in the heat transfer with the use of nanofluids [25–37].

Researches on using helical coil heat exchanger and also that on heat transfer improvement due to nanofluids have been widely done earlier. But there are very few reports on the heat transfer enhancement due to a coupled effect of application of helical coil heat exchanger and nanofluids which seems to be crucial. In this study, CuO–PANI/water nanofluids were prepared with varying loading (1, 3 and 5 wt.%) of CuO nanoparticles in the CuO–PANI nanocomposite. Thermal conductivity of the nanofluid was measured and compared with different volume fraction of nanocomposite in water as well as with nanocomposites possessing different loading of CuO nanoparticles. In addition, axial change of heat transfer coefficient was studied for different concentrations of nanofluids having nanocomposite of different loading (weight fraction) of CuO nanoparticles flowing at different Reynolds number.

2 Experimental

2.1 Materials

The chemicals used for the preparation of CuO–PANI nanocomposite were of analytical grade. Copper acetate monohydrate [$\text{Cu} (\text{CH}_3\text{COO})_2 \cdot \text{H}_2\text{O}$], glacial acetic acid, sodium hydroxide, ammonium persulfate, sodium dodecyl sulphate, hydrochloric acid and aniline were procured from Loba Chemie, Pvt. Ltd, Mumbai, India. Distilled water was used throughout the experimentation.

2.2 CuO nanoparticle preparation

CuO nanoparticles preparation was carried out with the use of the method given by Fule et al. [35] and Bhanvase et al. [37]. As reported by Fule et al. [35], synthesis of CuO nanoparticles was carried out by using 0.2 M copper acetate solution, glacial acetic acid and 8 M sodium hydroxide solution in distilled water. In the typical synthesis of CuO nanoparticles, 600 mL of 0.2 M copper acetate solution mixed with 2 mL of glacial acetic acid in a beaker and was heated to 80 °C under constant stirring with the help of magnetic stirrer due to which the subsequent color obtained was bluish. In the resultant solution, the addition of 30 mL of 8 M sodium hydroxide solution was accomplished which resulted in the formation of black precipitate in the solution. The obtained solution was boiled and stirred for 2 h. The formed CuO nanoparticles were separated by centrifugation, washed with distilled water several times in order to remove the impurities and dried in oven at 60 °C temperature.

Table 1 Summary of work done in reported literature on enhancement in heat transfer using nanofluids.

Nanofluid	Concentration	Type of heat exchanger used	Heat transfer coefficient/ Nusselt number enhancement	Significant Findings	Ref.
Al ₂ O ₃ /water	0.1-0.8 vol.%	Shell and helical coiled tube heat exchanger	17-28 %	Fluid flowing through the helical coil intensifies the formation of secondary flow and promotes mixing of the fluid	[25]
TiO ₂ /water	2 vol.%	Straight tube and Helical coiled tube heat exchanger	1330 W/m ² °C 4720 W/m ² °C	Secondary flow taking place in the coil improves heat transfer significantly	[26]
Al ₂ O ₃ /water	0.1-0.8 vol.%	Shell and helical coiled tube heat exchanger	21-42 %	Reason behind enhancement in the heat transfer coefficient is decrease in thermal boundary thickness as the nanofluid is passed through the coiled tube.	[27]
Numerical study in helical pipe	--	Helical coil		Dean number is the controlling parameter in helical coil.	[28]
Polyaniline (PANI)/water	0.08-0.24 vol.%	-	-	Highest thermal conductivity enhancement of 140% was reported for 0.24 vol.%.	[29]
Polyaniline (PANI)/water	0.2 and 1.2 wt.%	Straight tube heat exchanger	33 and 63 %	Polyaniline nanoparticles in the fluid augments the heat transfer performance of the fluid.	[30]
Polyaniline (PANI)/water	0.1 and 0.5 vol.%	Vertical helically coiled tube heat exchanger	10.52 and 69.62 %	Heat transfer coefficient to be 515.8 W/m ² °C for PANI nanofluid having 0.5 vol.%	[31]
CuO/ethylene glycol	1-5 vol.%	-	-	Thermal conductivity enhancement for the studied nanofluid range was found to be 4 to 22.4 %	[32]
CuO/ethylene glycol and CuO engine oil	0-2 vol.%	-	-	Thermal conductivity enhancement for the studied nanofluid range was found to be 13 to 19 %, 5-10 % and 5-8 % for distilled water, ethylene glycol and engine oil respectively.	[33]
CuO/base oil	2 wt.%	Horizontal helical tube	30.4 %		[34]
CuO/water	for 0.1 vol.% and 0.5 vol.%	Helical coil heat exchanger	37.3 % and 77.7 %	Average heat transfer coefficient was 99.9 W/m ² °C for Reynolds number of 812 while it increased to 544.46 W/m ² °C at Reynolds number of 1895	[35]
Polyaniline (PANI)-CuO	-	-	-	Polyaniline (PANI)-CuO nanocomposites are synthesized and it is shown that it exhibit synergistic hybrid properties which are derived from both its components	[36]
Polyaniline (PANI)/water	0.5 vol.%	Straight tube heat exchanger	>12 %	Higher enhancement offered by PANI-CuO nanofluid is attributed to the PANI encapsulated CuO nanocomposite	[37]

2.3 CuO–PANI nanocomposite preparation

Preparation of CuO–PANI nanocomposite was accomplished by ultrasound assisted in situ emulsion polymerization in the presence of prepared CuO nanoparticles. Initially 500 mL of 1 M HCl solution was prepared in distilled water. Further initiator and surfactant solution were prepared in distilled water by adding 3 g sodium dodecyl sulphate in 20 mL distilled water and 5 g ammonium persulfate in 50 mL distilled water, respectively. CuO nanoparticles were added to the surfactant solution on basis of weight percentage of aniline. All these prepared

solutions were added in the sonochemical reactor equipped with probe sonicator (Make: Dakshin, 240 W, 22 kHz) and were sonicated for 30 min. The temperature of this resultant mixture was maintained at 4 °C and 10 mL of aniline was added in the reaction mixture. Further, the resultant reaction mixture was sonicated for 1 h at 4 °C, which leads to the formation of CuO–PANI nanocomposite particles. During reaction, dark green color of the suspension was observed, which confirmed the formation of PANI. For loading of 1, 3, and 5 wt. wt.% of CuO nanoparticles in PANI, 0.09, 0.27 and 0.45 g CuO nanoparticles were added

in the reaction mixture which resulted into formation of 1% CuO–PANI nanocomposite, 3% CuO–PANI nanocomposite, and 5 % CuO–PANI nanocomposite, respectively. The formed nanocomposite particles were separated by centrifugation, washed with distilled water and dried in an oven at 80 °C. Dried CuO–PANI nanocomposite particles were then used for the preparation of CuO–PANI nanocomposite based nanofluid in water as a base fluid.

2.4 Characterization

UV/Vis spectra of CuO nanoparticles, 1 % CuO–PANI nanocomposite, 3 % CuO–PANI nanocomposite, and 5 % CuO–PANI nanocomposite were recorded on UV/VIS Spectrophotometer (LABINDIA UV3200 model). XRD patterns of CuO nanoparticles, 1 % CuO–PANI nanocomposite, 3 % CuO–PANI nanocomposite, and 5 % CuO–PANI nanocomposite were obtained by using powder X-ray diffractometer (Rigaku Mini-Flox, USA). The morphology of CuO nanoparticles and 5 % CuO–PANI nanocomposite was investigated by Transmission Electron Microscopy (TEM), (PHILIPS, CM200, 20–200 KV, magnification 1,000,000X).

2.5 CuO–PANI nanocomposite nanofluid preparation

In order to maintain the desired properties of the nanofluids, it is necessary to get uniform, stable and long lasting suspension with minimum agglomeration of the particles in nanofluids. Therefore, in the present work, the preparation of CuO–PANI nanocomposite based nanofluids was carried with the use of hydrodynamic cavitation. Hydrodynamic cavitation is a process in which cavities are generated by passing the liquid through a constriction such as orifice plate. When the liquid passes through the constriction, the kinetic energy associated with the liquid increases at an expense of the local pressure. When the pressure at the throat or vena-contracta of the constriction falls below the vapor pressure of the liquid, the liquid flashes, generating number of cavities that subsequently collapse when the pressure recovers downstream of the mechanical constriction. The collapse of these cavities generates extreme environment (temperature of the order of 10,000 K, and pressures of about 1000 atm) which results in the high turbulence and shearing action in the liquid medium. In order to prepare CuO–PANI nanocomposite based nanofluid, the said nanocomposite was first pulverized from the flakes formed during drying into powdered form. Then the CuO–PANI nanocomposite powder prepared in this study was added in the distilled water which is the base fluid in varying volume percentage. With the aim of prevention of any

agglomeration, the nanofluid solution was passed through hydrodynamic cavitation setup. In this work, during the preparation of nanofluid no dispersing agent was used to stabilize the nanocomposite particles in the nanofluid as this might change the effective thermal conductivity of the nanofluids. The volume percentage selected for 1 wt.% CuO–PANI nanocomposite based nanofluid was 0.05, 0.10, 0.15, 0.20 and 0.30 vol.%. Further for the case of 3 wt.% CuO–PANI nanocomposite and 5wt.% CuO–PANI nanocomposite, 0.05 volume % was selected for the preparation of nanofluids which is used for the study of effect of CuO loading of in CuO–PANI nanocomposite.

2.6 Thermal conductivity measurement of CuO–PANI nanocomposite based nanofluid

The thermal conductivity of CuO–PANI nanocomposite based nanofluids was measured with the use of KD2 Pro Thermal Properties Analyzer (Decagon Devices Inc., Pullman, WA, USA). This procedure follows the standards of ASTM D5334 and works on the principle of measurement based on the transient hot-wire source approach. This instrument is comprised of readout unit and sensor that is single needle. The needle i.e. thermal probe (1.27-mm diameter, 60-mm length) which have heating element and a thermoresistor was inserted in the CuO–PANI nanocomposite based nanofluids vertically. The measurement was made by heating the probe within the sample, at the same time the temperature change of the probe was monitored. In this system thermal stability was confirmed in first 90 s and in last 30 s the probe was heated with the help of controlled intensity. The change in the temperature during this process is recorded by thermistor and data is stored in microprocessor. The thermal conductivity of CuO–PANI nanocomposite based nanofluids was measured for different volume percentage of nanofluids and at different temperatures and was reported in this manuscript.

2.7 Experimental set up and procedure

A schematic diagram of the experimental setup used in the present study, is depicted in Fig. 1. It was the same experimental setup used in our previous study [31, 35]. The experimental setup depicted in Fig. 1 was built as closed loop system consisting of a nanofluid tank, pump, flow rate measuring unit, heat transfer section and cooling section. The heart of the system consists of a vertical helical copper coil having internal diameter of 13 mm, outside diameter of 15 mm and length of 10 m. The diameter of the helical coil was 290 mm with pitch of 35 mm and number

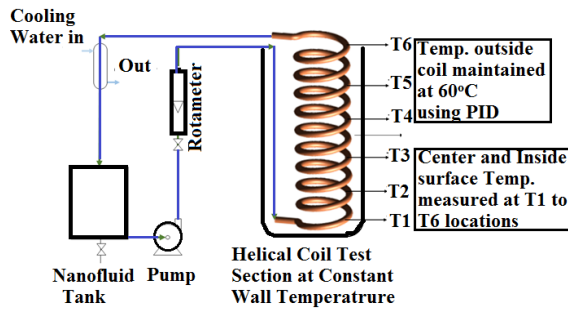

Fig. 1 Schematic of the experimental set up for convective heat transfer study for PANI–CuO nanofluids.

of turns was 12. The tubes have vertically down entry with pipe of same inside diameter and exit at the top followed by cooling section.

The coil was equipped with J-type thermocouples which indicated the temperature of inner fluid as well as inner wall of tube of alternate turn. These thermocouples were soldered at distance of 165 cm, 330 cm, 495 cm, 660 cm, 825 cm and 990 cm from the entrance of the tube. Digital temperature indicator was used to display thermocouple output. Flow rate of nanofluid was measured using rotameter and readings were taken at various flow rates ranging from 40 LPH to 80 LPH. Nanofluid from the tank was circulated in the experimental setup by means of pump. The assembly of helical coil and thermocouples was kept in a circular tank fabricated by sheet metal.

2.8 Physical properties determination by correlations

The density, heat capacity, viscosity and thermal conductivity of the nanofluids were estimated using following correlations because these are the important properties used for the calculation of heat transfer rate. In these correlations, the nanoparticles were assumed to be uniformly dispersed in the base-fluid. The density of CuO–PANI nanocomposite based nanofluids was estimated for various volume concentrations using following correlations [38, 39]:

$$\rho_{nf} = \phi\rho_p + (1 - \phi)\rho_{bf}. \quad (1)$$

The specific heat of CuO–PANI nanocomposite based nanofluids were calculated in the present work using Eq. (2) [39].

$$C_{p,nf} = \phi C_p + (1 - \phi)C_{bf}. \quad (2)$$

The viscosity of CuO–PANI nanocomposite based nanofluids was estimated using following equation:

$$\mu_{nf} = \mu_f (1 + 2.5\phi). \quad (3)$$

The effective thermal conductivity of CuO–PANI nanocomposite based nanofluids of mono-disperse, low volume-fraction mixtures of spherical particles was estimated as [40]:

$$k_{nf} = \frac{k_p + 2k_{bf} + (2\phi k_p - k_{bf})}{k_p + 2k_{bf} - \phi(k_p - k_{bf})} k_{bf}. \quad (4)$$

2.9 Convective heat transfer measurement

The following correlation was used for the estimation of the convective heat transfer coefficient at an axial distance ‘x’ from inlet in a straight tube, which is given by:

$$h(x) = \frac{q_s}{T_s(x) - T_b(x)} \quad (5)$$

where q_s heat flux applied to the fluid; $T_s(x)$ the wall temperature at a distance ‘x’ from the inlet, and $T_b(x)$ the fluid bulk temperature being measured at a distance ‘x’ from the inlet.

Further, the equation given below was used for the calculation of the heat transfer coefficient in the case of helical coil:

$$h_{i(coil)} = h_{i(straight)} \left(1 + 3.5 \frac{D}{D_c} \right). \quad (6)$$

Where D is diameter of inside tube and D_c is the diameter of helix.

The heat flux was estimated with the use of Eq. (7):

$$q_s = \frac{\dot{m}C_{p,nf} (T_{b,o} - T_{b,i})}{A} \quad (7)$$

where, T_{bo} , T_{bi} and A are the bulk fluid outlet temperature, bulk fluid inlet temperature and inner surface area respectively of the copper helical coil.

3 Results and discussion

3.1 UV-visible, TEM and XRD analysis

The UV-visible absorption spectra of CuO nanoparticles and CuO–PANI nanocomposites for different loading of CuO nanoparticles are depicted in Fig. 2. In case of CuO nanoparticles, broad absorption peaks at 300 and 355 nm were observed. Whereas, in case of CuO–PANI nanocomposite, the absorption peak observed at 330 nm is attributed to Π - Π^* transition of Benzenoid ring. Further the absorption peak at 440 nm is attributed to the Polaron $-\Pi^*$ transition. The absorption peak at around 620 nm is due to the transitions from localized benzene molecular orbital to a quinonoid molecular orbital [41]. Further, the absorption peaks of CuO nanoparticles were observed in the same wavelength range.

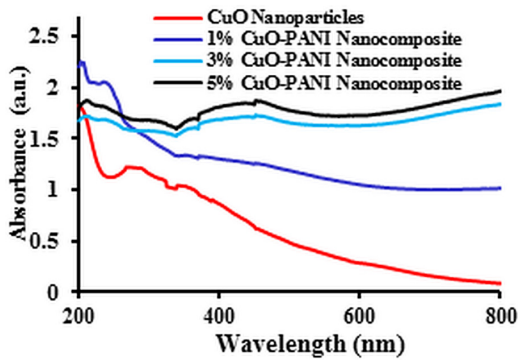

Fig. 2 UV-visible absorption spectra of CuO Nanoparticles, 1 % CuO–PANI Nanocomposite, 3 % CuO–PANI Nanocomposite and 5 % CuO–PANI Nanocomposite

Fig. 3 depicts the TEM images of CuO nanoparticles (A and B) and CuO–PANI nanocomposite (C and D). From Fig. 3 A and B, it has been observed that the CuO nanoparticles are rod-shaped and have uniform particle size consistently less than 10 nm without showing any agglomeration. Fig. 3 C and D shows TEM images of CuO–PANI nanocomposite particles prepared by ultrasound assisted in situ emulsion polymerization. The TEM images depict the fine and uniform dispersion of CuO nanoparticles in PANI matrix resulting in the formation of finely dispersed CuO–PANI nanocomposite particles. This is attributed to the physical effects of the ultrasound, which generates turbulence and micro mixing due to implosion of the cavities in the reaction medium that will give synergetic effect in the properties of CuO–PANI nanocomposite based nanofluids.

Fig. 4 shows the XRD pattern of CuO nanoparticles and CuO–PANI nanocomposite particles. The characteristic peaks at 35.1, 38.2, 48.4, 52.9, 57.8, 61.3, 65.5 and 67.7° corresponding to the planes at (0 0 2), (1 1 1), (2 0 2), (0 2 0), (2 0 2), (1 1 3), (3 1 1) and (2 2 0), shows monoclinic phase of CuO nanoparticles (JCPDS Card. No. 89–5899) [37, 42, 43]. This confirms the formation of crystalline CuO nanoparticles. The XRD pattern of CuO–PANI nanocomposite is depicted in Fig. 4. The peaks at 19.9, 22.4, 27.1° are characteristics of PANI (EB). In the presence of CuO nanoparticles the peaks of PANI becomes weaker. Further, the peaks of CuO nanoparticles in the case of CuO–PANI nanocomposite becomes too weak which is attributed to lesser loading of CuO nanoparticles in PANI matrix.

3.2 Effect of concentration of nanofluid on thermal conductivity ratio

Fig. 5 depicts the thermal conductivity ratio of 1 wt.% CuO–PANI nanocomposite (with 1 wt.% loading of CuO

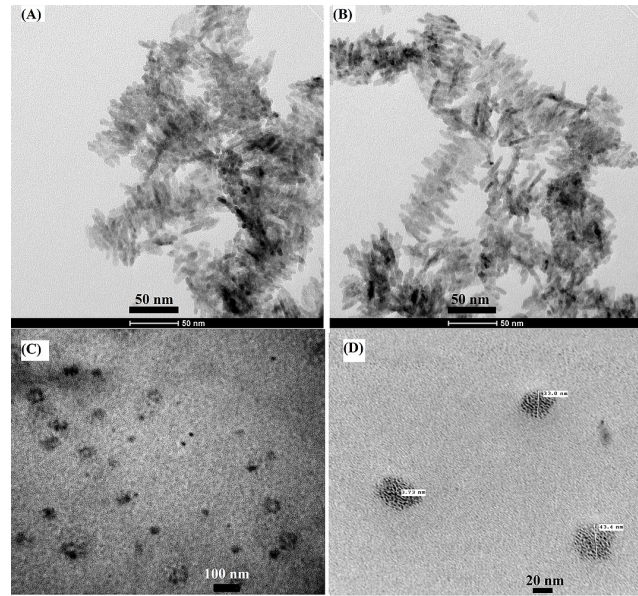

Fig. 3 TEM Images of (A and B) CuO Nanoparticles, (C and D) 5% CuO–PANI nanocomposite

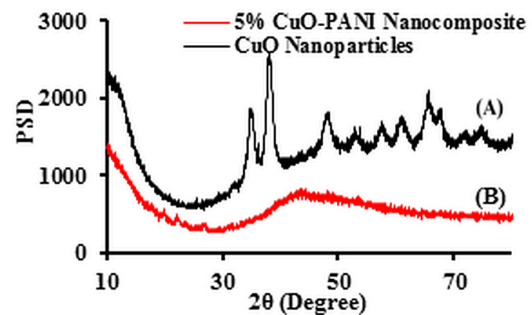

Fig. 4 XRD pattern of (A) CuO Nanoparticles and (B) 5% CuO–PANI nanocomposite

nanoparticles in the nanocomposite) based nanofluids prepared using distilled water as a base fluid against the temperature of the nanofluids for different concentrations (volume %). As can be seen from the graph, the thermal conductivity ratio of all the prepared nanofluids having 0.1, 0.2, 0.3 and 0.4 vol.% concentration increases with increase in temperature. Along with this, it is clear that the increasing concentration shows an increasing trend in thermal conductivity ratio with a highest ratio exhibited by the 0.4 vol.% concentrated nanofluid recorded to be 2.10 at 40 °C.

It has been already known that the addition of nanoparticles to the base fluid leads to enhancement in the thermal conductivity of the nanofluids. Further, an increase in the temperature intensifies the Brownian motion of the nanoparticles which in turn enhances the thermal conductivity of the nanofluids. Similar results were obtained for nanofluids containing CuO–PANI nanocomposite

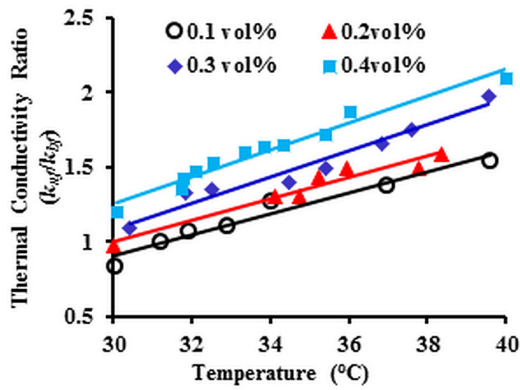

Fig. 5 Thermal conductivity ratio of 1 % CuO–PANI nanocomposite based nanofluids with water as the base fluid with respect to temperature at different vol.%.

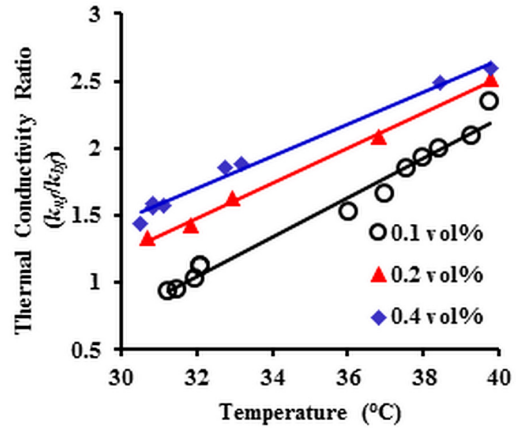

Fig. 6 Thermal conductivity ratio of 3% CuO–PANI nanocomposite based nanofluids with water as the base fluid with respect to temperature at different vol.%.

composed of 3 wt.% CuO nanoparticles at concentrations of 0.1, 0.2 and 0.4 vol.% as shown in Fig. 6.

The thermal conductivity ratios obtained for 0.1, 0.2 and 0.4 vol.% nanofluids are 2.34, 2.51 and 2.59, respectively at 40 °C. The increase in thermal conductivity ratio with temperature for nanofluids containing CuO–PANI nanocomposite composed of 5 wt.% CuO nanoparticles has also been observed (Fig. 7) for different concentrations with the highest shown by 0.5 vol.% nanofluid as 3.87 at 48.8 °C. An enhancement in the thermal conductivity of CuO–PANI nanocomposite based nanofluid with an increase in the loading of CuO nanoparticles in the said nanocomposite is attributed to increase in the content of the CuO nanoparticles in the CuO–PANI nanocomposite. As the thermal conductivity CuO nanoparticle is higher, it contributes in the enhancement in the thermal conductivity of resulted nanocomposite based nanofluids.

3.3 Effect of CuO loading in the nanocomposite on thermal conductivity ratio

Fig. 8 illustrates the thermal conductivity ratio of CuO–PANI nanocomposite based nanofluids having 0.5 vol.% concentration against temperature for different loading of CuO nanoparticles in the nanocomposite, namely 1 wt.%, 3 wt.% and 5 wt.%. The highest increase in thermal conductivity ratio of 3 is shown by the nanofluid containing CuO–PANI nanocomposite with 5 wt.% CuO loading at 42 °C. As the thermal conductivity of copper is very high, an increase in its concentration in the CuO–PANI nanocomposite shall augment the thermal conductivity of the nanocomposite. This result in the higher thermal conductivity ratios presented by nanofluids prepared using the CuO–PANI nanocomposite possessing higher CuO nanoparticles concentration.

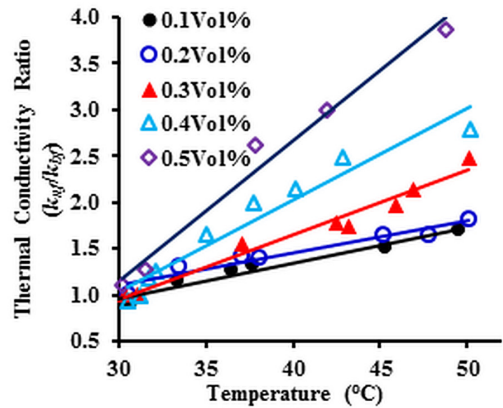

Fig. 7 Thermal conductivity ratio of 5% CuO–PANI nanocomposite based nanofluids with water as the base fluid with respect to temperature at different vol.%.

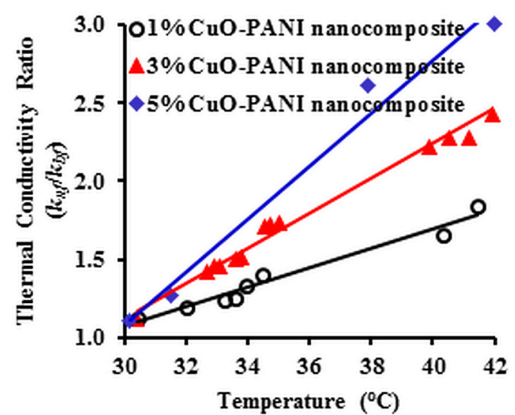

Fig. 8 Thermal conductivity ratio of CuO–PANI nanocomposite based 0.5 vol.% nanofluids for different loading (wt%) of CuO nanoparticles in CuO–PANI nanocomposite with water as the base fluid with respect to temperature.

3.4 Effect of concentration of nanofluid on heat transfer coefficient

Fig. 9 shows the trend of heat transfer coefficient with respect to axial position for the flow of the nanofluids with different 1wt.% CuO–PANI nanocomposite concentration at Reynolds number of 1890. It is clear from the Fig. 9 that the heat transfer coefficient increases with an increase in the CuO–PANI nanocomposite concentration in nanofluid. This is because of higher thermal conductivity possessed by the higher concentration CuO–PANI nanocomposite in nanofluid as known earlier. Also, a large number of nanoparticles present in the nanofluid bring about more chaotic movements thus disturbing the thermal boundary layer present at the tube wall surface formed as a form of heat transfer resistance. At lower axial distance i.e. at the entrance of the test section, the value of heat transfer coefficient is large which is attributed to the entrance effect. After a certain axial distance, the decline in heat transfer coefficient becomes gradual due to developed thermal boundary layer. The rise in the concentration of the nanofluid results in a delay in thermal boundary layer formation thus increasing the heat transfer coefficient. At the exit (i.e. $x/D_i = 761.5$), heat transfer coefficient for water is found to be $335.1 \text{ W/m}^2\text{°C}$ and that for 0.3 vol.% CuO–PANI nanofluid with 1 wt.% CuO nanoparticles in CuO–PANI nanocomposite is $460.4 \text{ W/m}^2\text{°C}$. Significant enhancement in heat transfer coefficient was observed with increase in the volume % of nanocomposite particles in the base fluid. The possible reasons are stated above. Also, addition of CuO–PANI nanocomposite particle in the nanofluid increases the effective thermal conductivity and reduces the thickness of the boundary layer. The heat transfer coefficient is the ratio of thermal conductivity and thickness of boundary layer. Therefore, increase in

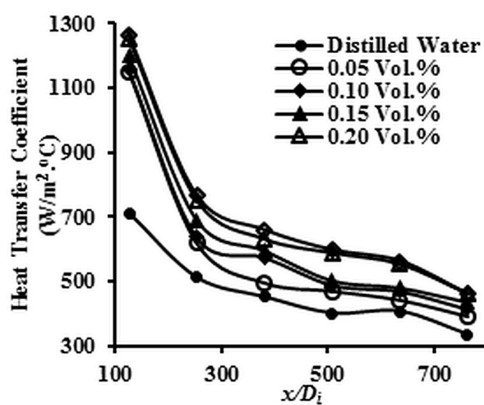

Fig. 9 Trend of heat transfer coefficient (h) vs the axial position at different 1% CuO–PANI nanocomposite concentration ($Re=1890$)

the thermal conductivity and decrease in the thickness of boundary layer results in the increase in the heat transfer coefficient of the nanocomposite based nanofluid. Also Brownian motion plays significant role in the enhancement of heat transfer coefficient. Also with the use of helical coiled heat exchanger it is possible to generate the secondary flow that improves heat transfer significantly compared to that of in straight tube, which is well defined by Dean number. Further with an increase in the volume percentage of the nanoparticles in the basefluid, the marginal increase in the pressure drop and friction factor is reported in the literature. However, in the present work we have used hydrodynamic cavitation for the preparation of nanofluids which confirms the fine dispersion of the nanocomposite particle in the basefluid. Therefore, slight increment in the pumping power at higher concentration of nanocomposite particles can be predicted.

Fig. 10 shows the effect of concentration of 1wt.% CuO–PANI nanocomposite based nanofluids flowing at Reynolds number of 1890 ± 5 on the heat transfer coefficient enhancement measured at outlet of the test section.

As it can be seen in the figure, a maximum enhancement of 37.4 % in the heat transfer coefficient provided by the 1wt.% CuO–PANI nanocomposite based nanofluids is at 0.2 vol.% concentration after which there is no further enhancement in the heat transfer coefficient as compared with the base fluid. This is due to the agglomeration or setting of particles taking place at the high concentration. Large amount of nanoparticles flowing inside the test section can tend to settle at the bottom wall of the coil resulting into less nanoparticles flowing through the coil. This helps to conclude that the nanofluid concentration of 0.2 vol.% is the optimum concentration required to achieve maximum heat transfer enhancement.

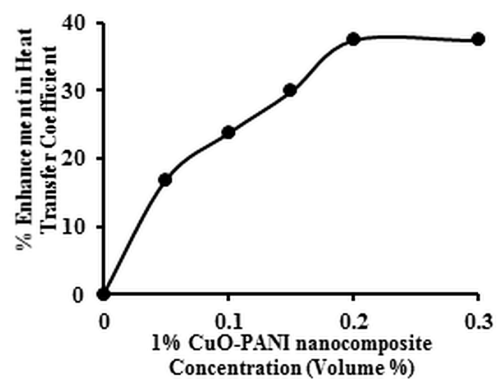

Fig. 10 Effect of 1% CuO–PANI nanocomposite concentration in nanofluid on heat transfer coefficient enhancement (at $x/D_i = 761.5$ i.e. at outlet of the helical coil and $Re = 1890 \pm 5$)

3.5 Effect of CuO loading in the nanocomposite on heat transfer coefficient

The effect of loading of CuO in CuO–PANI nanocomposite on the heat transfer coefficient for 0.05 vol.% concentration of nanofluid can be seen in Fig. 11. It can be found that the nanofluid containing CuO–PANI nanocomposite composed of higher loading of CuO nanoparticles in CuO–PANI nanocomposite has higher heat transfer coefficient. The highest heat transfer coefficient was observed to be 460.8 W/m² °C for the 5 wt.% loading CuO nanoparticles. At the exit of the test section, the heat transfer coefficient was found to be increased from 391.6 to 460.8 W/m² °C with an increase in the loading of CuO nanoparticles from 1wt% to 5 wt% in CuO–PANI nanocomposite. This is attributed to the higher thermal conductivity of CuO–PANI nanocomposite composed of higher loading of CuO nanoparticles as discussed earlier. Thus, more the loading of CuO in the CuO–PANI nanocomposite, higher will be the enhancement in the heat transfer coefficient.

3.6 Effect of Reynolds number on heat transfer coefficient

The heat transfer coefficient for 0.2 vol.% concentration of nanofluid containing 1 wt.% CuO–PANI nanocomposite at different Reynolds number is plotted against axial distance in Fig. 12. It is seen that higher Reynolds number depict higher heat transfer coefficient, which is attributed to the increased turbulence of the nanofluid with an increase in the Reynolds number. For Reynolds number equal to 1079, the heat transfer coefficient was found to be 263.2 W/m² °C, which is found increased to 592.1 W/m² °C for the Reynolds number equal to 2158 at the exit of the test section. This is due to the turbulence at higher Reynolds number, which

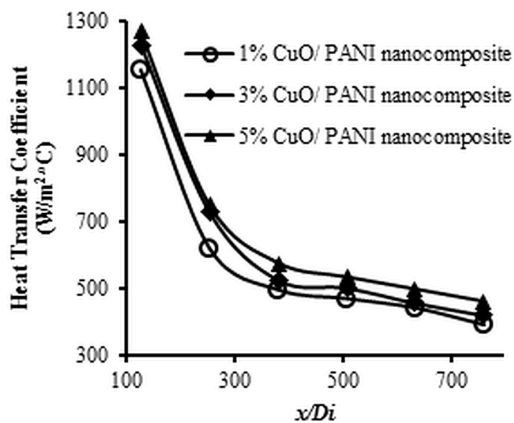

Fig. 11 Effect of percentage loading of CuO in CuO–PANI nanocomposite for its 0.05 volume % concentration in nanofluid on heat transfer coefficient (Re = 1890 ± 5)

facilitates chaotic movement of the nanoparticles resulting in increase in heat transfer coefficient. Fig. 13 shows the increasing trend of heat transfer coefficient with respect to Reynolds number measured at outlet of the test section for a 1 wt.% CuO–PANI nanocomposite based nanofluid with 0.2 vol.% concentration. With the increase in Reynolds number, eddies are developed in the flow that reduces the thickness of boundary layer and that results in enhancement in the heat transfer coefficient.

4 Conclusions

The convective heat transfer study was successfully carried out in the present study using CuO–PANI nanocomposite based nanofluid at various volume % (0.05 to 0.3) in a helical coiled tube heat exchanger at different Reynolds number ranging from 1079–2158. Also the effect of loading of CuO nanoparticles in the CuO–PANI nanocomposite on heat transfer coefficient of nanofluid was studied. It has been observed that an increase in the volume % of CuO–PANI nanocomposite, Reynolds number and CuO loading in the nanocomposite shows significant enhancement

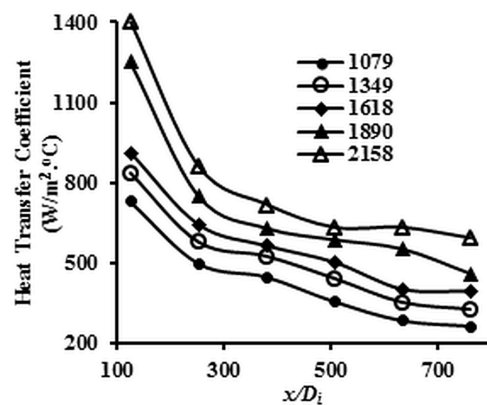

Fig. 12 Trend of heat transfer coefficient (*h*) vs the axial position at different values of Reynolds Number for 1 % CuO–PANI nanocomposite at 0.2 Vol. % concentration.

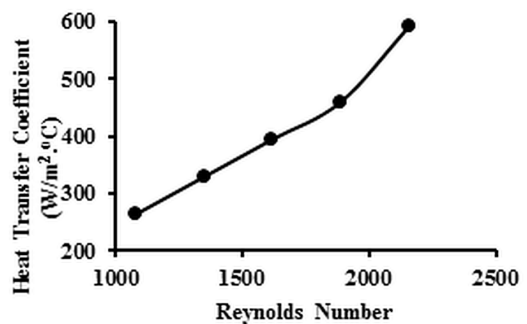

Fig. 13 Effect of Reynolds number of 1% CuO–PANI nanocomposite based nanofluid on heat transfer coefficient (at $x/Di = 761.5$ i.e. at outlet of the helical coil and Volume % = 0.2)

in the thermal conductivity and heat transfer coefficient. The CuO–PANI nanocomposite in the present study was successfully prepared by ultrasound assisted in situ emulsion polymerization method and used for the preparation of nanofluids. An increase in the loading of CuO nanoparticles in CuO–PANI nanocomposite shows a noteworthy increase in the heat transfer coefficient of nanofluid from 391.6 to 460.8 W/m² °C at 0.05 volume %. Around 17 % enhancement in the heat transfer coefficient was observed at 0.05 volume % concentration of 1wt.% CuO–PANI nanocomposite and 37.4 % enhancement at 0.2 volume %. Therefore, the use of CuO–PANI nanocomposite based nanofluid is a superior option wherever higher heat transfer rate is expected.

Nomenclature

A	Inner surface area of the copper helical coil (m ²)
C_p	Heat capacity of nanoparticles (J/kgK)
C_{bf}	Heat capacity of base fluid (J/kgK)
$C_{p_{nf}}$	Heat Capacity of nanofluid (J/kgK)
D	Diameter of inside tube of helical coil (m)
Dc	Diameter of helix (m)
$hi_{(coil)}$	Heat Transfer coefficient in helical coil (W/m ² °C)
$hi_{(straight)}$	Heat Transfer coefficient in straight tube (W/m ² °C)
K_{bf}	Thermal conductivity of base fluid (W/mK)
K_{nf}	Thermal conductivity of nanofluid (W/mK)
K_p	Thermal conductivity of nanoparticles (W/mK)

References

- [1] Bergles, A. E. "Recent development in convective heat transfer augmentation", Applied Mechanics Reviews, 26, pp. 675–682, 1973.
- [2] Das, S. K., Choi, S. U. S., Patel, H. E. "Heat Transfer in Nanofluids-A Review", Heat Transfer Engineering, 27(10), pp. 3–19, 2006. <https://doi.org/10.1080/01457630600904593>
- [3] Choi, S. U. S., Eastman, J. A. "Enhancing thermal conductivity of fluids with nanoparticles", presented at ASME International Mechanical Engineering Congress & Exposition, San Francisco, California, USA, Nov. 12-17, 1995.
- [4] Eastman, J. A., Choi, U. S., Li, S., Thompson, L. J., Lee, S. "Enhanced Thermal Conductivity through the Development of Nanofluids", MRS Online Proceedings Library, 457, pp. 3–12, 1996. <https://doi.org/10.1557/PROC-457-3>
- [5] Xuan, Y., Li, Q. "Heat transfer enhancement of nanofluids", International Journal of Heat and Fluid Flow, 21(1), pp. 58–64, 2000. [https://doi.org/10.1016/S0142-727X\(99\)00067-3](https://doi.org/10.1016/S0142-727X(99)00067-3)
- [6] Maiga, S. E. B., Palm, S. J., Nguyen, C. T., Roy, G., Galanis, N. "Heat transfer enhancement by using nanofluids in forced convection flows", International Journal of Heat and Fluid Flow, 26, pp. 530–546, 2005. <https://doi.org/10.1016/j.ijheatfluidflow.2005.02.004>
- [7] Murshed, S. M. S., Leong, K. C., Yang, C. "Investigations of thermal conductivity and viscosity of nanofluids", International Journal of Thermal Sciences, 47, pp. 560–568, 2008. <https://doi.org/10.1016/j.ijthermalsci.2007.05.004>
- [8] Kakaç, S., Pramuanjaroenkij, A. "Review of convective heat transfer enhancement with nanofluids", International Journal of Heat and Mass Transfer, 52, pp. 3187–3196, 2009. <https://doi.org/10.1016/j.ijheatmasstransfer.2009.02.006>
- [9] Chougule, S. S., Sahu, S. K. "Comparative study of cooling performance of automobile radiator using Al₂O₃-water and carbon nanotube-water nanofluid", Journal of Nanotechnology in Engineering and Medicine, 5, article ID 010901, 2014. <https://doi.org/10.1115/1.4026971>

L	Length of tube (m)
\dot{m}	Mass flow rate of fluid (kg/s)
q_s	Heat flux applied to the fluid (W/m ²)
r	Radius of tube (m)
$T_b(x)$	Fluid bulk temperature being measured at a distance 'x' from the inlet (°C)
$T_s(x)$	Wall temperature at a distance 'x' from the inlet (°C)
T_{bi}	Bulk fluid inlet temperature of the copper helical coil (°C)
T_{bo}	Bulk fluid outlet temperature of the copper helical coil (°C)
T_i	Inlet fluid temperature ((°C))
T_o	Outlet fluid temperature ((°C))
T_s	Wall temperature ((°C))
ρ_{nf}	Density of nanofluid (kg/m ³)
ρ_p	Density of nanoparticles (kg/m ³)
ρ_{bf}	Density of base fluid (kg/m ³)
ϕ	Volume fraction of nanoparticles in nanofluid
μ_{nf}	Viscosity of nanofluid (N.s/m ²)
μ_f	Viscosity of fluid (N.s/m ²)

Acknowledgement

This work was supported by the Science & Engineering Research Board (SERB), Department of Science and Technology (Government of India) [Start Up Research Grant (Young Scientists), Sanction order no. YSS/2014/000889, 2015].

- [10] Sandhya, D., Reddy, M. C. S., Rao, V. V. "Improving the cooling performance of automobile radiator with ethylene glycol water based TiO₂ nanofluids", *International Communications in Heat and Mass Transfer*, 78, pp. 121–126, 2016.
<https://doi.org/10.1016/j.icheatmasstransfer.2016.09.002>
- [11] Otanicar, T. P., Phelan, P. E., Prasher, R. S., Rosengarten, G., Taylor, R. A. "Nanofluid-based direct absorption solar collector", *Journal of Renewable and Sustainable Energy*, 2, article ID 033102, 2010.
<https://doi.org/10.1063/1.3429737>
- [12] Han, D., Meng, Z., Wu, D., Zhang, C., Zhu, H. "Thermal properties of carbon black aqueous nanofluids for solar absorption", *Nanoscale Research Letters*, 6, article ID 457, 2011.
<https://doi.org/10.1186/1556-276X-6-457>
- [13] Karami, M., Bahabadi, M.A.A., Delfani, S., Ghozatloo, A. "A new application of carbon nanotubes nanofluid as working fluid of low-temperature direct absorption solar collector", *Solar Energy Materials and Solar Cells*, 121, pp. 114–118, 2014.
<https://doi.org/10.1016/j.solmat.2013.11.004>
- [14] Tsai, C. Y., Chien, H. T., Ding, P. P., Chan, B., Luh, T. Y., Chen, P. H. "Effect of structural character of gold nanoparticles in nanofluid on heat pipe thermal performance", *Materials Letters*, 58, pp. 1461–1465, 2004.
<https://doi.org/10.1016/j.matlet.2003.10.009>
- [15] Selvakumar, P., Suresh, S. "Convective performance of CuO/water nanofluid in an electronic heat sink", *Experimental Thermal and Fluid Science*, 40, pp. 57–63, 2012.
<https://doi.org/10.1016/j.exptthermflusci.2012.01.033>
- [16] Tombacz, E., Bica, D., Hajdu, A., Illes, E., Majzik, A., Vekas, L. "Surfactant double layer stabilized magnetic nanofluids for biomedical application", *Journal of Physics: Condensed Matter*, 20, article ID 204103, 2008.
<https://doi.org/10.1088/0953-8984/20/20/204103>
- [17] Sharifi, I., Shokrollahi, H., Amir, S. "Ferrite-based magnetic nanofluids used in hyperthermia applications", *Journal of Magnetism and Magnetic Materials*, 324, pp. 903–915, 2012.
<https://doi.org/10.1016/j.jmmm.2011.10.017>
- [18] Imani-Mofrad, P., Saeed, Z.H., Shanbedi, M. "Experimental investigation of filled bed effect on the thermal performance of a wet cooling tower by using ZnO/water nanofluid", *Energy Conversion and Management*, 127, pp. 199–207, 2016.
<https://doi.org/10.1016/j.enconman.2016.09.009>
- [19] Askari, S., Lotfi, R., Seifkordi, A., Rashidi, A. M., Koolivand, H. "A novel approach for energy and water conservation in wet cooling towers by using MWNTs and nanoporous graphene nanofluids", *Energy Conversion and Management*, 109, pp. 10–18, 2016.
<https://doi.org/10.1016/j.enconman.2015.11.053>
- [20] Saliyani, M., Jalal, R., Goharshadi, E. K. "Effects of pH and temperature on antibacterial activity of zinc oxide nanofluid against *Escherichia coli* O157: H7 and *Staphylococcus aureus*", *Jundishapur Journal of Microbiology*, 8, article ID e17115, 2015.
<https://doi.org/10.5812/jjm.17115>
- [21] Rufus, A., Sreeju, N., Philip, D. "Synthesis of biogenic hematite (α -Fe₂O₃) nanoparticles for antibacterial and nanofluid applications", *RSC Advances*, 6, pp. 94206–94217, 2016.
<https://doi.org/10.1039/C6RA20240C>
- [22] Zhang, L., Qi, H., Yan, Z., Gu, Y., Sun, W., Zewde, A. A. "Sonophotocatalytic inactivation of *e. coli* using ZnO nanofluids and its mechanism", *Ultrasonics Sonochemistry*, 34, pp. 232–238, 2017.
<https://doi.org/10.1016/j.ultsonch.2016.05.045>
- [23] Oka, C., Ushimaru, K., Horiishi, N., Tsuge, T., Kitamoto, Y. "Core-shell composite particles composed of biodegradable polymer particles and magnetic iron oxide nanoparticles for targeted drug delivery", *Journal of Magnetism and Magnetic Materials*, 381, pp. 278–284, 2015.
<https://doi.org/10.1016/j.jmmm.2015.01.005>
- [24] Prabhanjan, D. G., Raghavan, G. S. V., Rennie, T. J. "Comparison of heat transfer rates between a straight tube heat exchanger and a helically coiled heat exchanger", *International Communications in Heat and Mass Transfer*, 29, pp. 185–191, 2002.
[https://doi.org/10.1016/S0735-1933\(02\)00309-3](https://doi.org/10.1016/S0735-1933(02)00309-3)
- [25] Mukesh Kumar, P. C., Kumar, J., Suresh, S. "Experimental investigation on convective heat transfer and friction factor in a helically coiled tube with Al₂O₃/water nanofluid", *Journal of Mechanical Science and Technology*, 27, pp. 239–245, 2013.
<https://doi.org/10.1007/s12206-012-1206-9>
- [26] Kahani, M., Heris, S. Z., Mousavi, S. M. "Experimental investigation of TiO₂/water nanofluid laminar forced convective heat transfer through helical coiled tube", *Heat and Mass Transfer*, 50, pp. 1563–1573, 2014.
<https://doi.org/10.1007/s00231-014-1367-4>
- [27] Mukesh Kumar, P. C., Kumar, J., Sendhilnathan, S., Tamilarasan, R., Suresh, S. "Heat transfer and pressure drop of Al₂O₃ nanofluid as coolant in shell and helically coiled tube heat exchanger", *Bulgarian Chemical Communications*, 46(4), pp. 743–749, 2014.
- [28] Liu, S., Masliyah, J. H. "Axially invariant laminar flow in helical pipes with a finite pitch", *Journal of Fluid Mechanics*, 251, pp. 315–353, 1993.
<https://doi.org/10.1017/S002211209300343X>
- [29] Wan, M., Yadav, R. R., Yadav, K. L., Yadav, S. B. "Synthesis and experimental investigation on thermal conductivity of nanofluids containing functionalized Polyaniline nanofibers", *Experimental Thermal and Fluid Science*, 41, pp. 158–164, 2012.
<https://doi.org/10.1016/j.exptthermflusci.2012.03.030>
- [30] Gurav, P., Naik, S., Bhanvase, B.A., Pinjari, D. V., Sonawane, S. H., Ashokkumar, M. "Heat transfer intensification using polyaniline based nanofluids: preparation and application", *Chemical Engineering and Processing: Process Intensification*, 95, pp. 195–201, 2015.
<https://doi.org/10.1016/j.cep.2015.06.010>
- [31] Bhanvase, B. A., Sayankar, S. D., Kapre, A., Fule, P. J., Sonawane, S. H. "Experimental investigation on intensified convective heat transfer coefficient of water based PANI nanofluid in vertical helical coiled heat exchanger", *Applied Thermal Engineering*, 128, pp. 134–140, 2018.
<https://doi.org/10.1016/j.applthermaleng.2017.09.009>
- [32] Liu, M. S., Lin, M. C. C., Huang, I. T., Wang, C. C. "Enhancement of thermal conductivity with CuO for nanofluids", *Chemical Engineering & Technology: Industrial Chemistry Plant Equipment Process Engineering Biotechnology*, 29, pp. 72–77, 2006.
<https://doi.org/10.1002/ceat.200500184>

- [33] Agarwal, R., Verma, K., Agrawal, N. K., Duchaniya, R. K., Singh, R. "Synthesis, characterization, thermal conductivity and sensitivity of CuO nanofluids", *Applied Thermal Engineering*, 102, pp. 1024–1036, 2016.
<https://doi.org/10.1016/j.applthermaleng.2016.04.051>
- [34] Hashemi, S. M., Akhavan-Behabadi, M. A. "An empirical study on heat transfer and pressure drop characteristics of CuO–base oil nanofluid flow in a horizontal helically coiled tube under constant heat flux", *International Communications in Heat and Mass Transfer*, 39, pp. 144–151, 2012.
<https://doi.org/10.1016/j.icheatmasstransfer.2011.09.002>
- [35] Fule, P. J., Bhanvase, B. A., Sonawane, S. H. "Experimental investigation of heat transfer enhancement in helical coil heat exchangers using water based CuO nanofluid", *Advanced Powder Technology*, 28, pp. 2288–2294, 2017.
<https://doi.org/10.1016/j.apt.2017.06.010>
- [36] Nadaf, L. I., Venkatesh, K. S. "Polyaniline-Copper Oxide Nanocomposites: Synthesis and Characterization", *Material Science Research India*, 12(2), pp. 108–111, 2015.
<https://doi.org/10.13005/msri/120204>
- [37] Bhanvase, B. A., Kamath, S. D., Patil, U. P., Patil, H. A., Pandit, A. B., Sonawane, S. H. "Intensification of heat transfer using PANI nanoparticles and PANI-CuO nanocomposite based nanofluids", *Chemical Engineering and Processing: Process Intensification*, 104, pp. 172–180, 2016.
<https://doi.org/10.1016/j.cep.2016.03.004>
- [38] Lee, S., Choi, S. S., Li, S. A., Eastman, J. A. "Measuring of Thermal Conductivity of Fluids Containing Oxide Nanoparticles", *Journal of Heat Transfer*, 121, pp. 280–289, 1999.
<https://doi.org/10.1115/1.2825978>
- [39] Pak, B. C., Cho, Y. I. "Hydrodynamic and heat transfer study of dispersed fluids with submicron metallic oxide particles", *Experimental Heat Transfer an International Journal*, 11, pp. 151–170, 1998.
<https://doi.org/10.1080/08916159808946559>
- [40] Maxwell, J. C. "A Treatise on Electricity and Magnetism", Clarendon Press, Oxford, UK, 1881.
- [41] Shubha, L. N., Kalpana, M., Madhusudana Rao, P. "Study of chemically synthesized polyaniline/copper oxide nanocomposites", In: *Proceedings of the National Seminar on Frontiers in Chemical Research and Analysis*, Hyderabad, India, 2015, pp. 1–4.
- [42] Chen, D., Shen, G., Tang, K., Qian, Y. "Large-scale synthesis of CuO shuttle-like crystals via a convenient hydrothermal decomposition route", *Journal of Crystal Growth*, 254, pp. 225–228, 2003.
[https://doi.org/10.1016/S0022-0248\(03\)01170-9](https://doi.org/10.1016/S0022-0248(03)01170-9)
- [43] Jundale, D. M., Navale, S. T., Khuspe, G. D., Dalavi, G. S., Patil, P. S., Patil, V. B. "Polyaniline–CuO hybrid nanocomposites: synthesis, structural, morphological, optical and electrical transport studies", *Journal of Materials Science: Materials in Electronics*, 24, pp. 3526–3535, 2013.
<https://doi.org/10.1007/s10854-013-1280-5>